

dCS Paganini Transport
Upsampling CD / SACD Transport

User Manual
Software Release 1.0x
June 2010

© Data Conversion Systems Ltd. 2007-2010

Price UK £8.00 / Euro 12.00

All rights reserved. No part of this publication may be reproduced, stored in or introduced into a retrieval system, or transmitted in any form, or by any means (electronic, mechanical, photocopying, recording or otherwise) without the prior written permission of *dCS*¹. Any person who does any unauthorised act in relation to this publication may be liable to criminal prosecution and civil claims for damages.

Information contained in this manual is subject to change without notice, and whilst it is checked for accuracy, no liabilities can be accepted for errors.

¹ *dCS* is Data Conversion Systems Ltd. Company registered in England No. 2072115.

Contents

Using the dCS Paganini Transport for the first time	4
What's in the box?	4
Positioning the unit	4
Safety Notice	5
Which types of disc can be played?	6
Which types of disc can NOT be played?	6
Laser Radiation	6
Step-by-Step Guide	7
Preliminaries	7
Fitting the Remote Control handset batteries	8
STEP 1 – Selecting a Digital Output	9
STEP 2 – Choosing a Sync Mode	10
Using the DAC in Master Mode	10
Using a Master Clock	11
STEP 3 – Playing a Disc	12
STEP 4 – Other Features	12
Front Panel	13
POWER Button	13
MENU Button	13
JOG BACK Button	13
JOG FORWARD Button	13
STOP / EJECT Button	13
PLAY / PAUSE Button	14
Previous Track Button	14
Next Track Button	14
Remote Control Receiver	14
Display	14
CD Tray	14
Rear Panel	15
Mains inlet	15
Word Clock Input / Output	15
PCM Outputs	15
1394 Interface	15
SUC Connector	15
Remote Control	16
The Menu	17
Using the Menu	18
INFORMATION Menu	19
TRANSPORT SETTINGS Menu	20
DISPLAY SETTINGS Menu	20
SIGNAL GENERATOR Menu	21
Specification	22
Maintenance and Support	23
Service and Maintenance	23
Replacing a Blown Mains Fuse	23
Cleaning the case	23
Limited Warranty	24
If you need more help	25
Software History	25

USING THE *dCS Paganini Transport* FOR THE FIRST TIME

Congratulations on purchasing your *dCS Paganini Transport*.

Before using your unit, please read this section and the Step by Step Guide. This will enable you to set the unit up quickly and safely with your hi-fi system.

From time to time, *dCS* will release updated software on CD that you can install yourself using the **CD Update** feature. Please check our web-site occasionally to see if new *Paganini* software is available, or consult your dealer.

What's in the box?

Check that the box contains the following items:

- *dCS Paganini Transport*
- Manual and Menu / Setup Guide
- Power cable
- 1394 cable
- BNC cable
- 2 spare fuses
- Remote Control
- 2x AAA batteries

Notify your dealer as soon as possible if anything is missing or damaged. We suggest that you retain the original packaging for possible future use. If this is not possible, replacement packaging can be ordered from *dCS* or our distributors. Details can be found on our web site at www.dcsLtd.co.uk.

The cables supplied are commercial-grade parts, as we realise our customers will want to make their own choices.

Positioning the unit

Units in the Paganini range may be stacked directly on top of each other, but are likely to give better sonic results when mounted on separate shelves of a rack. Place each unit on a firm, vibration free base, allowing convenient connection to the other parts of your system. To prevent overheating, we recommend that you leave some free space around the unit to allow for ventilation.

3 feet are fitted as standard, this may be changed to the 4-foot arrangement shown below, if you prefer. Spare feet are available as an optional extra. The mounting points are M4 size, maximum screw depth is 10mm.

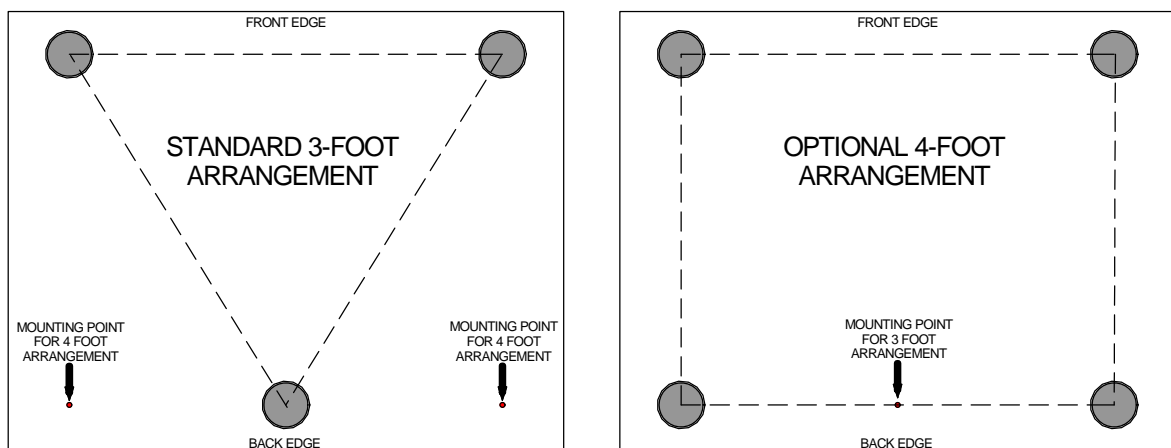

Safety Notice



Your *dCS Paganini Transport* contains no user serviceable parts. **DO NOT** attempt to open the case as there are potentially dangerous voltages present inside. In the event of the unit developing a fault, please contact your dealer in the first instance.

To maintain protection from electric shock, the unit **MUST** be connected to mains earth (ground) via the power cable. Also, unearthed systems do not give the best sonic performance.



This product is lead-free to comply with the RoHS directive.

Before connecting the power cable to the unit for the first time, please check that it has been set to the correct operating voltage for your mains supply. The unit's voltage setting is shown on the serial number label. If this does not match your local supply voltage, **DO NOT** attempt to use the unit. Contact your dealer to have the unit reset. Using the unit with the wrong mains setting for your local supply may result in serious damage to the unit and will invalidate the warranty. Do not attempt to reset the voltage yourself.

We do not recommend the use of mains regenerators. However, if you do wish to use a mains regenerator with variable voltage and frequency, we recommend that you set the voltage to match your local voltage and the frequency to either 50Hz or 60Hz **ONLY**.



Damage caused to your *Paganini Transport* by misuse of a mains regenerator or by a malfunctioning mains regenerator is not covered by the warranty.



Disposal at end-of-life - the symbol indicates that this product should not be treated as normal household waste. It should be recycled, so please take it to an approved collection facility.

Which types of disc can be played?



Commercially manufactured CDs can be played if they:

- are 12cm or 8cm round discs
- are recorded with linear PCM digital audio data
- carry the Compact Disc Digital Audio logo and meet the “Red-Book” standard.



Commercially manufactured single-layer SACDs or hybrid SACD/CD discs can be played if they:

- are 12cm or 8cm round discs
- are recorded with DSD digital audio data on the SACD layer
- carry the Super Audio CD logo and so meet the “Scarlet-Book” standard.

CD-R

CD-R or CD-RW discs recorded with audio data in CD format may be playable, but this depends on the disc, the software and the burner used to record on the disc. *dCS*

CD-RW

cannot accept responsibility for any difficulty encountered while attempting to play such discs.

Which types of disc can NOT be played?

dCS cannot accept responsibility for any difficulty encountered while attempting to play the following types of disc:

- Scratched, damaged or dirty discs.
- Printed or labelled CD-Rs or discs contaminated with glue or other sticky substances. These may get stuck inside the unit. If this happens, the warranty on the Transport will be void. A service charge will be made for removing such discs.
- DVD, CD-G, CD-EXTRA, PHOTO CD, CD-ROM or DVD-ROM.
- Copy-protected discs that do not conform to the “Red-Book” CD standard may not play correctly or may not play at all. Such discs are not CDs – they are optical discs that have been recorded with digital audio data. They should not carry the Compact Disc Digital Audio logo – but some do. If you encounter any difficulty playing such discs, please contact the disc manufacturer and demand a **genuine CD** in exchange.

Laser Radiation



dCS Paganini Transport is a Class 1 Laser Product, it complies with U.S. FDA 21CFR subchapter J. In normal use, there is no risk of exposure to laser radiation.



The case should only be opened by authorised service personnel. The case protects the user from indirect exposure to visible and invisible laser radiation, as well as risk of electric shock.

STEP-BY-STEP GUIDE

This section guides you through setting up the unit for basic operation.

Preliminaries

The Menu / Setup Guide sheet details the menu structure and details the two most common set-ups.

For digital interfaces, use with cables designed for digital audio:

- for AES/EBU interfaces use 110 Ω screened, twisted pair cables fitted with one male XLR connector and one female XLR connector.
- for Word Clock interfaces, use 75 Ω coax cables fitted with BNC plugs.
- for SPDIF RCA interfaces, use 75 Ω coax cables fitted with RCA Phono plugs.
- for IEEE 1394 interfaces, use the IEEE 1394 cable provided with the unit.

Switch on the rest of the system first. Connect the power cable supplied to the power inlet on the rear panel, plug the other end into a convenient power outlet.



Please do not use an excessively heavy or inflexible power cable as this may damage the power inlet connector.

Set the rear panel power switch to the **I** position. Briefly press the **Power** button and wait about 30 seconds while the Transport configures itself. The display will show in sequence: **Paganini Transport** and **No Disc**.

If the unit is likely to be set in an unfamiliar state, you can reset it as follows. Press the **Menu** button, press the **→** button once, then the **Menu** button again to display the **Transport Settings** menu. Press the **←** button repeatedly to highlight the **Factory Reset** menu page. Press the **Menu** button and wait a few seconds while the settings are reset.

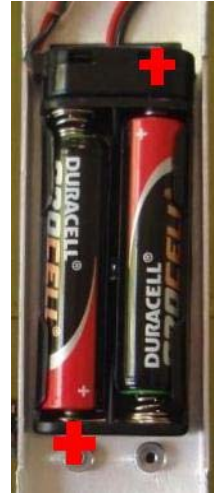
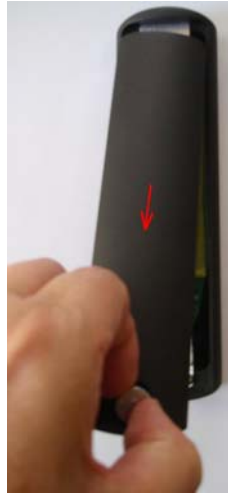
Fitting the Remote Control handset batteries

Use a small coin to release the screw securing the back plate.

Lift the screw a little and slide the back plate off.

Fit 2 AA size batteries by pressing the flat end (-) against the spring and pressing the battery into the slot, so that the + end makes contact with the stud.

Slide the back plate into place and tighten the screw.



Failure to fit the batteries correctly can damage your Remote Control. Such damage is not covered by the warranty.



Please dispose of used batteries properly at a waste disposal site, not in the household waste.

STEP 1 – Selecting a Digital Output

Whether you are playing a CD or an SACD, the 1394 interface carries DSD data and all of the PCM outputs carry CD-format data. Most owners connect the 1394 interface only, but some prefer to listen to CDs in the native 16 bit 44.1kS/s format.

Connecting the IEEE 1394 interface

- Connect **one 1394** output on the *Transport* to **one 1394** input on the *DAC*. Also connect the **W/Clk Out** on the *Transport* to the **W/Clk In** connector on the *DAC*.
- Press the *DAC Input* button repeatedly until **1394** or **dCS PTT** is displayed.

The *DAC* may display **Wait ...**, **No-WClk** or **Search..**, messages if the unit is still settling, then in sequence **(Clk OK)**, **Locking** and **No Audio**. If you have more than one source connected to the 1394 bus, it may be necessary to use the **Input** button to select the 1394 source you want to listen to. If the **EasyPlay** menu is set to **Full**, inserting a disc in the *Transport* will switch the *DAC* to the **1394** input.

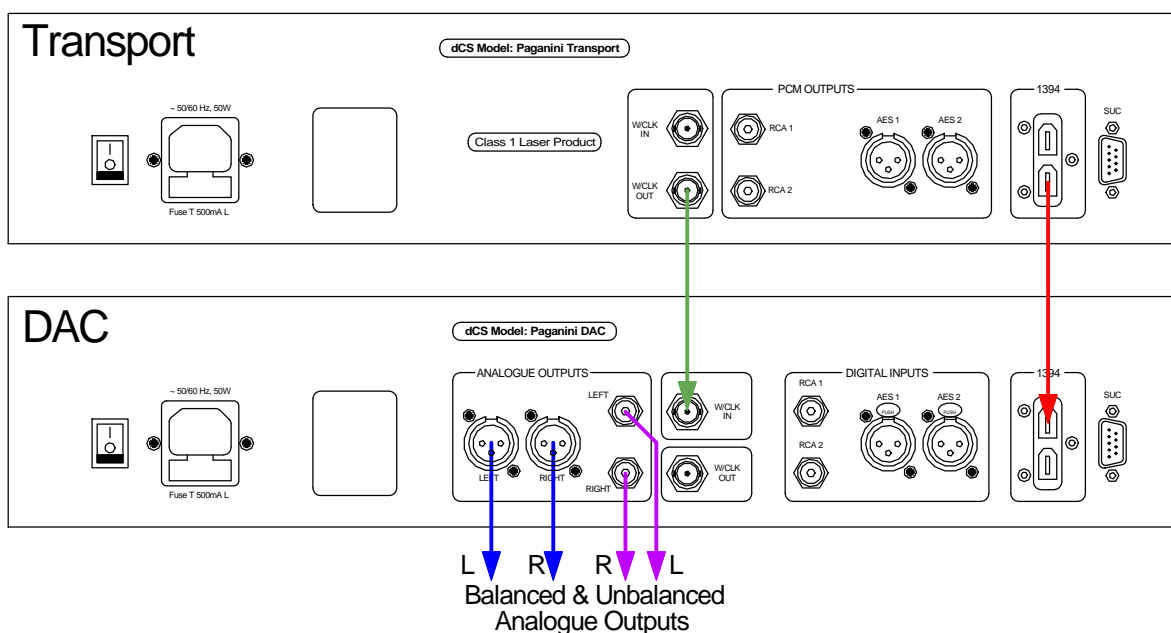

Figure 1 – Basic setup

Connecting a Single AES or RCA output

- Connect one of the outputs on the *Transport* to the matching input on the *DAC* using a suitable cable.
- Press the *DAC Input* button repeatedly until your chosen input is displayed. This will be either **AES1**, **AES2**, **RCA1** or **RCA2**.

The *DAC* will lock to the source, displaying in sequence **(44.1k)**, **Locking**, **16/44.1**.

Proceed to Step 2.

STEP 2 – Choosing a Sync Mode

So far, the system has been set up to lock to the clock generated by the source. If you are using the 1394 or SDIF interfaces, the DAC will lock to a word clock generated by the Transport. This is the simplest arrangement, but it does not give the best sonic performance due to clock jitter.

Using the DAC in Master Mode

If you have a *Paganini Clock*, go to the next page. You can reduce the jitter in your system by using the *Paganini DAC* in Master mode and slaving the *Transport* to it.

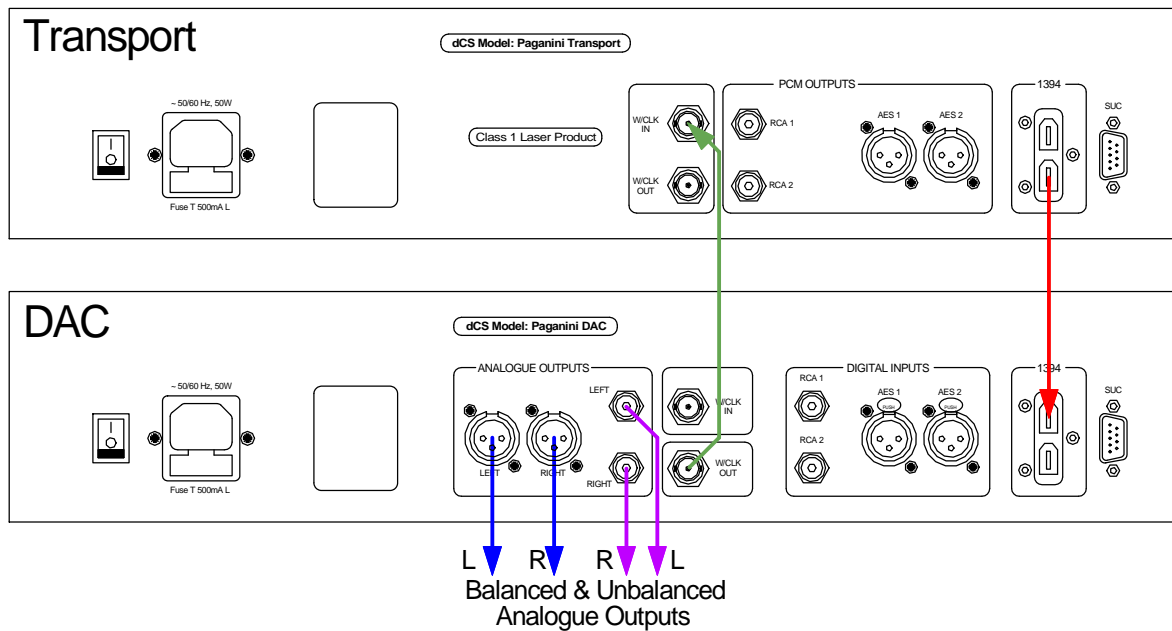

Figure 2 – Using the *Paganini* Transport with the DAC in Master Mode

- Use the *DAC*'s **Input** button to select the input you want to use.
- Connect the *DAC*'s **W/Clk Out** connector to the *Transport*'s **W/Clk In** connector.
- Press the **Sync** button to set the DAC to **Master** mode and allow the system to re-lock.

Using a Master Clock

The performance can be improved further by adding a *Paganini* Clock to the system as shown below.

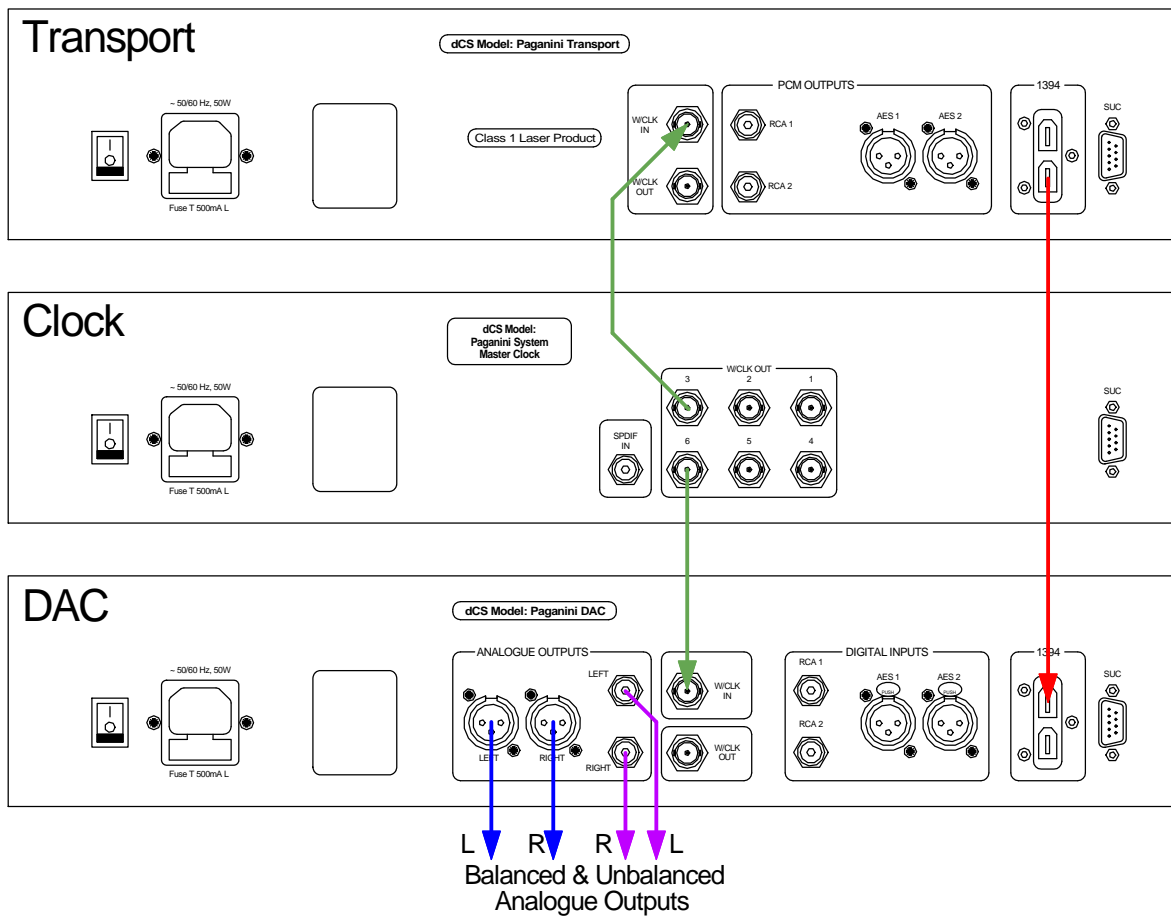

Figure 3 – Using the *Paganini* Transport, DAC and Clock together

- Use the *DAC*'s **Input** button to select the input you want to use.
- Connect two of the *Clock*'s **W/Clk Outputs** to the **W/Clk Inputs** of the *Transport* and *DAC*.
- Use the *Clock*'s **Frequency** button to set the outputs to **44.1kHz**, to suit the *Transport*.
- Use the *DAC*'s **Sync** button to set the *DAC* to **WClk** mode and allow the system to re-lock.

Please consult the Clock manual for more information on using a Master Clock.

Proceed to Step 3.

STEP 3 – Playing a Disc

- Press the  button.







The display will show **OPEN**.

- Load a CD or SACD into the tray with the label upwards and either push the tray in gently or press the  button again.

The display will show **CLOSE**, then **LOADING**. The disc type will be identified, either **CD** or **SACD** appears on the display, along with the number of tracks and the total playing time. The Transport will play the SACD layer of a hybrid disc by default, but you can select the CD layer instead using the menu.

- Press the  button to start the disc playing. Turn up the Volume to a comfortable level.

You should have audio. For all discs, the disc type and elapsed time will be displayed.



- Press the  button to pause playing, press again to resume playing.
- Press the  or  button to skip to the next track or the previous track.
- Press the  or  button to jog through the track. To go faster, press the button again (speed 2) and again (speed 3). Press the  button to return to play mode.
- Press the  button to stop the disc. Press it again to open the tray.

STEP 4 – Other Features

The Remote Control gives access to other features, such as track number selection, repeat track or disc and programming a track sequence.

To select track 5 as an example, either press button **5** and wait a few seconds or press **0** then **5** within the next few seconds (this is quicker). To select track 12, press **1** then **2**.

Press the **Repeat** button repeatedly to cycle through the options:

-  • **Repeat Track** - repeat the track that is currently playing.
-  • **Repeat Disc** - repeat the whole disc.
- **Repeat Off** – normal operation.

With the disc stopped, press the **Program** button to program a track sequence, next select the track numbers you want to play in any order. We suggest entering 2 digits for each track number, as this will allow you to enter the sequence more quickly. For example, pressing **Program 05 04 06 Play** will play track 5, then track 4, then track 6 and stop. The unit will display **6PGM3**, where 6 is the last track number entered and 3 is the number of tracks in the sequence. Press **Clear** to remove the last track from the sequence (track 6), the display will change to **4PGM2**. Press **Program** again to cancel program mode, the unit will display **Program Off**. Opening the CD tray also cancels program mode.

The next step is crucial – sit back and enjoy the music.

When you have finished listening, you can either keep the system warm by setting it to Sleep mode (press the **Power** button briefly) or switch off (hold down the **Power** button until **Power Down** is displayed, then release).

FRONT PANEL

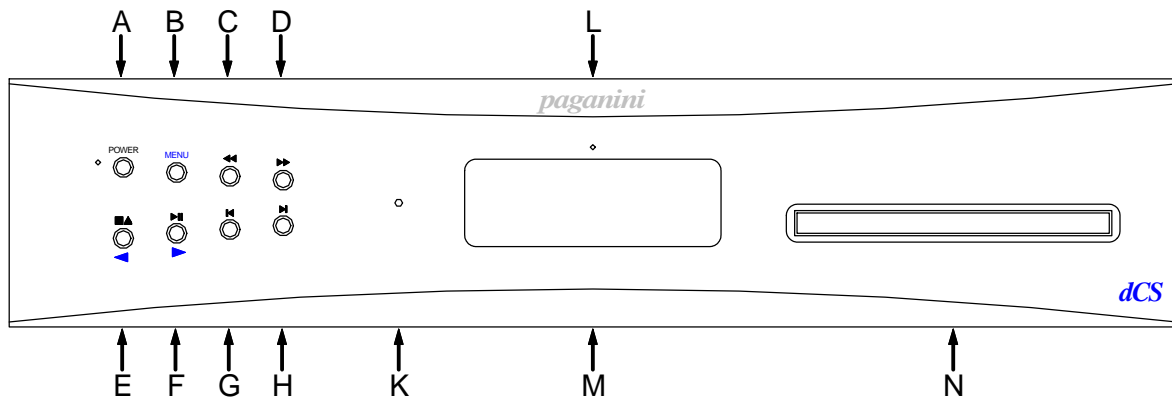

Figure 4 – Front panel

POWER Button

To switch on, ensure the rear panel switch is set to **I** and press the **POWER** button (A) on the front panel once. Note that the unit cannot be turned on from the remote control.

To set the unit to sleep mode, press the **POWER** button once. The main display will turn off, the LED to the left of the button will illuminate, and the outputs will mute, but the unit will remain close to running temperature. Press again to return to normal operation.

To switch off, hold down the **POWER** button for about 5 seconds until **Power Down** appears on the display, then release it.

When the menu is open, press the **POWER** button to close the menu.

MENU Button

Press the **MENU** button (B) to open the menu, select menu pages and change settings. See the Menu section on page 17 for information on using the menu features.

JOG BACK Button

◀◀ When a disc is playing, press this button (C) to jog back through the current track. Press again to jog faster (speed 2), press again to jog faster still (speed 3). Pressing this button a fourth time returns to **PLAY** mode. Jogging past the start of track 1 returns to **PLAY** mode.

JOG FORWARD Button

▶▶ When a disc is playing, press this button (D) to jog forward through the current track. Press again to jog faster (speed 2), press again to jog faster still (speed 3). Pressing this button a fourth time returns to **PLAY** mode. Jogging to the end of the disc stops the transport.

STOP / EJECT Button

■▲ Press the **STOP / EJECT** button (E) to stop playing a disc. Press again to open the CD tray. Press again to close the CD tray.

When the menu is open, the **STOP / EJECT** button changes to the < button, used to page backwards through the menu.

PLAY / PAUSE Button

After a disc has been read, press the **PLAY / PAUSE** button (F) to start playing. Press again to pause and again to resume playing.

When the menu is open, the **PLAY / PAUSE** button changes to the **>** button, used to page forwards through the menu.

Previous Track Button

Press this button (G) to skip to the previous track, or to the start of the current track if the disc is playing. This feature is easier to use when the disc is stopped or paused.

Next Track Button

Press this button (H) to skip to the next track. Skipping past the last track returns to track 1.

Remote Control Receiver

Aim the remote control handset towards the receiver (K) for best sensitivity.

Display

In normal use, the display (M) is split into 5 areas:

When stopped, the number of tracks on the disc is shown.
When playing or paused, the current track number is shown.

Track or disc time
(hours, minutes, seconds)

Total elapsed time or
Total remaining time or
Track elapsed time or
Track remaining time



Disc type or hybrid disc layer:
SACD or **CD**

This symbol indicates the mechanism status: Stop, Play, Pause, Fast Reverse, Fast Forward, Open or Close.

Sync will also appear here when the transport is locked to an external clock. While locking is in progress, **Sync** will appear greyed out. If a clock is present but the Transport cannot lock to it, **?Sync?** will be displayed and the Transport will use its own clock.

If a track sequence has been set up, **PGM** will appear here.

Details of the menu displays are shown in the Menu section on page 17.

If the display is turned off on the **Display Settings / Display Off** menu page, the LED (L) above the display illuminates.

CD Tray

When loading a CD or SACD into the CD tray (N), ensure the disc is central with the label upwards and is seated correctly.

REAR PANEL

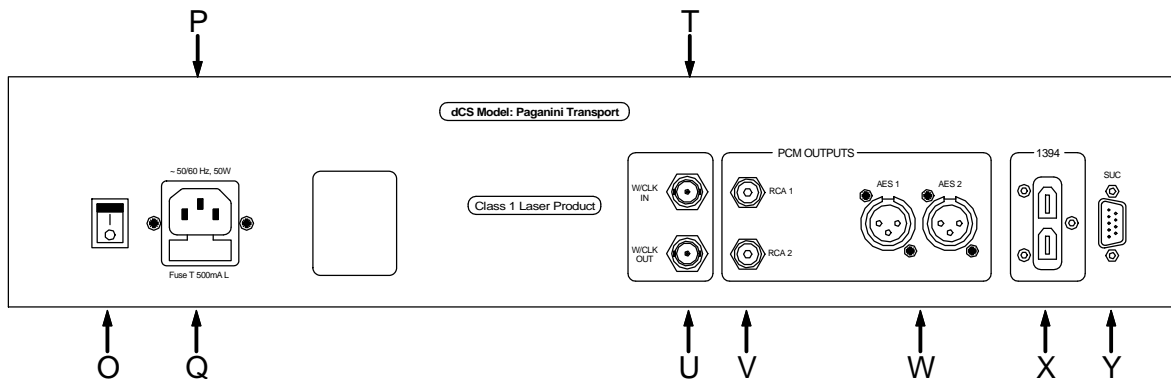

Figure 5 - Rear Panel

Mains inlet

Power is connected via a standard IEC320 connector (P), protected by a fuse (Q) and isolated by a 2-pole power switch (O).

Word Clock Input / Output

The **W/Clk In** connector (T) will accept standard 44.1kHz word clock from DAC in master mode or a master clock. **Sync** will appear on the display when the transport is locked to the external clock. **Sync** will appear greyed out for a few seconds during locking. If activity is detected but the Transport cannot lock to the clock signal (for example, because it is at the wrong frequency or level), **?Sync?** is displayed and the Transport uses its own clock.

The **W/Clk Out** connector (U) carries a 44.1kHz word clock.

Word clock is used for synchronisation only, it does not carry digital data.

PCM Outputs

The unit features 2 co-ax SPDIF outputs on RCA phono connectors, **RCA1** & **RCA2** (V), and 2 AES/EBU outputs on 3-pin XLR connectors, **AES1** & **AES2** (W). These outputs carry CD format data (16 bits at 44.1kS/s), either direct when playing a CD or down-sampled when playing an SACD.

1394 Interface

The IEEE 1394 interface (X) outputs encrypted DSD data. 1394 interfaces are great for carrying lots of digital data - but are very poor at transmitting a stable clock, so a separate Word Clock connection is required. The two 1394 ports are identical – they can be used as data outputs or as a loop-through. Note that the 1394 bus must not be connected in a loop as this will prevent the system initialising.

SUC Connector

The **SUC** connector (Y) is an RS232 interface, primarily used to remotely control the unit during automated testing. Please contact *dCS* for advice on using this interface with a household automation system. Note that we recommend using infra-red remote control instead.

REMOTE CONTROL

The upper section of the Remote Control is mainly for the DAC, the lower section is for the Transport.



Hold down the **Sleep** button for 2 seconds to set the system to sleep mode. Press the **Sleep** button again to return to normal operation.

In Sleep mode, press the **OFF** button to turn the system off.

The **Upsampler Input** button selects the input. The **Upsampler Output** button selects the output sample rate.

The **Filter** button changes the DAC filter setting.

The **Balance** button toggles the DAC between Volume and Balance adjustment modes.

The **AES** button selects the DAC's AES input, the **1394** button selects the DAC's 1394 input.

The **Input +** and **Input -** buttons cycle through the available inputs.

The **Vol+** and **Vol-** buttons adjust the DAC's Volume / Balance. **Mute** turns the DAC's outputs off and on.

The **Program** and **Clear** buttons are used with the **0 - 9** buttons to set or change a track sequence for the loaded disc.

The **0 - 9** buttons select the current track. Pressing **5** or **05** will select track 5.

The **Stop/Eject**, **Play/Pause**, **Previous Track**, **Next Track**, **Jog Back** and **Jog Forward** buttons operate in the same way as those on the Transport front panel.

The **Repeat** button cycles through **Repeat 1** (repeat the current track), **Repeat** (repeat the whole disc) and **Repeat Off**.

The **Display** button changes the time displayed on the Transport, cycling through **Track Elapsed**, **Track Remaining**, **Disc Elapsed** and **Disc Remaining**.

When the system is completely off (not just in sleep mode), press the front panel **Power** buttons to turn it on. You cannot use the Remote Control for this. The **OFF** button will only operate if the system is in sleep mode.

If you have more than one 1394 source connected, the Remote's **1394** button will select the first source. Use the Remote's **Input +** button to select other sources.

THE MENU

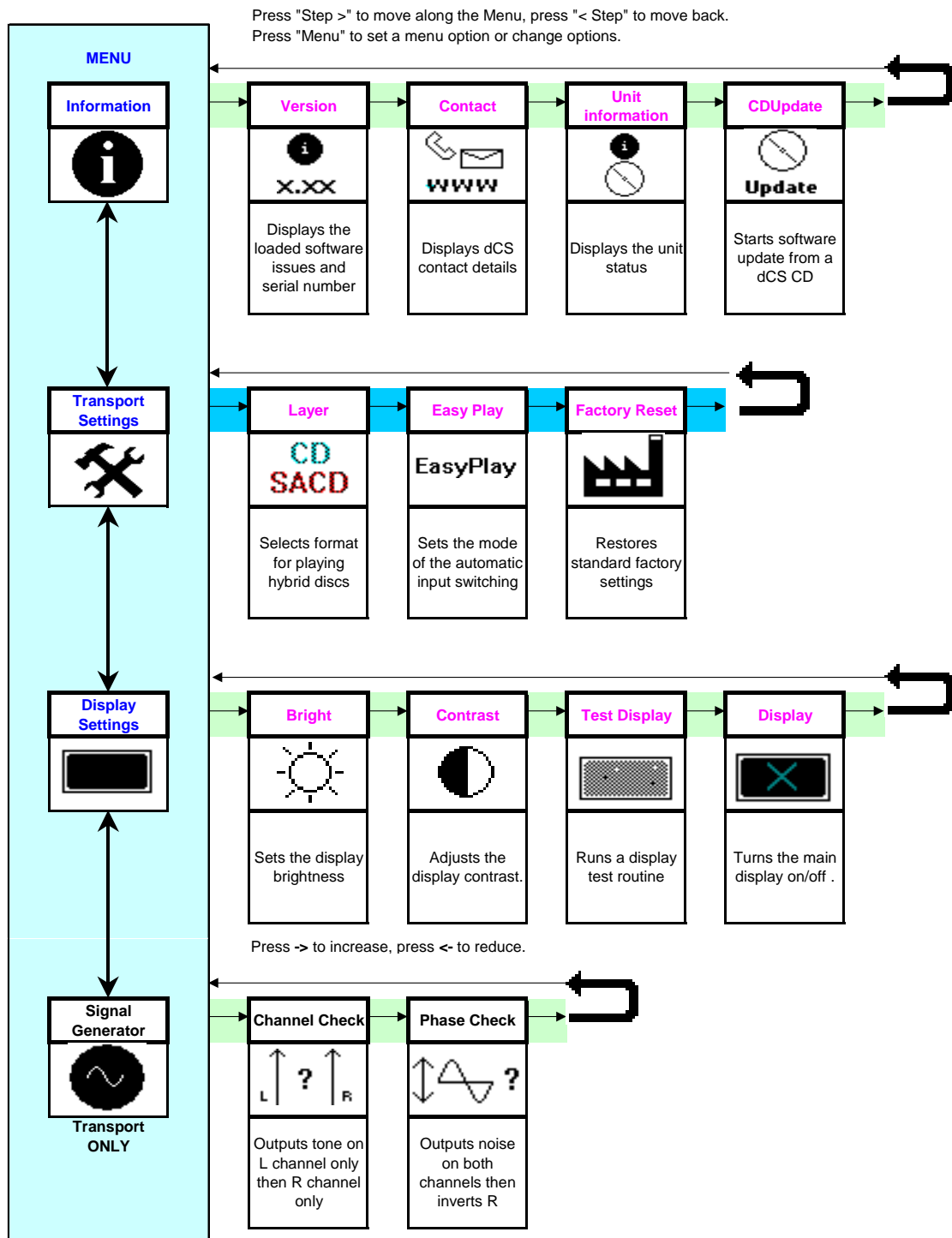

Figure 6 – The menu sequence

Using the Menu

The menu gives the user access to a range of additional features. It also allows new features and performance enhancements to be added at a later date by software upgrades.

The menu is controlled by four buttons.



Press the **MENU** button to open the menu or select a setting.

Press the **>** button to page forward through the menu.

Press the **<** button to page backward through the menu.

Press the **POWER** button to close the menu or just wait 5 seconds.

Use the Menu Guide sheet to help you find the right menu.

Each unit in the range has either three or four top-level menu pages:



The **INFORMATION** menu gives software issues, serial number, contact details and unit set-up details.



The **SETTINGS** menu allows you to set some features that are not directly accessible from the front panel.



The **DISPLAY SETTINGS** menu is used to adjust and test the display.



The **SIGNAL GENERATOR** menu is used to check the system during set-up.

Use the **>** button to move the highlight to the menu you want, then press the **MENU** button to select it. The next menu level down is displayed. Use the **>** button to move the highlight to the menu page you want, then press the **MENU** button to display the information or change the setting.



Select the exit icon to go back to the previous menu level.

INFORMATION Menu

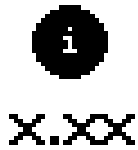

The **Version** page displays the software versions loaded in the unit and the full serial number. Please have this information ready if you contact your dealer for any reason.

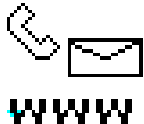

The **Contact** page displays dCS web-site URL, email address, telephone and fax numbers. If you have any difficulty, please contact your dealer for help first.



The **Transport Information** page displays the unit status:

- Area: No Disc / CD / SACD
- WClk In: Inactive / 44.1kHz
- I/F version: x.xx
- B/E version: x.xx
- F/E version: x.xx

Use the < and > buttons to scroll down the list and press the **MENU** button to exit.



The **CD Update** feature allows you to load new software into your *Paganini Transport*. Please follow the instructions supplied with the update CD carefully.

While playing an SACD, CD Updating is not possible and the icon will be greyed out. Use the front panel controls during an update as the remote control may not operate.



If you accidentally start a CD Update, switch off the unit at the back panel switch, wait 10 seconds, then switch on again.

TRANSPORT SETTINGS Menu



When playing a hybrid disc, the **Layer** page allows you to select either the **CD** or **SACD** layer. The active layer will be shown as dark, the other layer will be greyed out. While changing layers and re-reading the disc, **Please wait...** is displayed.

EasyPlay

The **EasyPlay** system automatically selects the right DAC input to suit the type of disc being played. The **EasyPlay** system requires that the DAC is locked to a source when the disc is loaded and a direct 1394 connection between Transport & DAC. The Transport examines the interconnections between units then stores a setup for CD and a setup for SACD. There are 3 options:

- **EasyPlay Off** disables the automatic switching. You will need to set the DAC input to match the type of disc being played.
- **EasyPlay Full** sets the DAC to the **1394#0** input (Transport channel), whether a CD or SACD is played.
- **EasyPlay SACD** sets the DAC to the **1394#0** input when an SACD is played. When a CD is played, the system sets the DAC to the input that is sourced from the Transport, either directly or via an Upsampler. If there is more than one route between the 2 units (ignoring the direct **1394#0** connection) the input is selected in this order of priority: **1394#1** (Upsampler channel), **Dual AES** (via Upsampler), **AES1**, **AES2**, **RCA1**, **RCA2**. (Selection of the Upsampler's 1394 channel requires DAC software issue 1.10 or later).



The **Factory Reset** menu page resets the unit to standard settings. These are:

Hybrid **Layer** to **SACD**.
Easy Play to **Full**.
Display to On.
Brightness to maximum.
Contrast to 60%.
 Programmed sequences cleared.
 Repeat to Off.

DISPLAY SETTINGS Menu

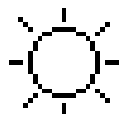

Set the display **Brightness** to a comfortable level using the **<** and **>** buttons.



Set the display **Contrast** to a comfortable level using the **<** and **>** buttons.



Runs a **Display Test** routine, which flashes all the indicators and the main display.



Display On / Off.

SIGNAL GENERATOR Menu

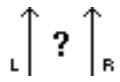

Use the **Channel Check** routine to test the system for swapped channels. A tone is output on the left channel only while the display shows **Left**, then the right channel only while the display shows **Right**. If these are the wrong way around, the left and right channels are swapped somewhere in your system.



Use the **Phase Check** routine to test the system for phase reversals. Noise is output in phase on both channels while the display shows **In Phase**. Press the **MENU** button, the noise on the right channel is inverted while the display shows **Out of Phase**. The first burst should produce a central image, the second burst should not. If these are the wrong way around, one channel in your system is phase inverted. Press the **<** or **>** button to stop the test and return to the menu.

SPECIFICATION

Mechanism type	Dual laser CD/SACD mechanism.
Digital outputs	IEEE 1394 interface on 2x 6-way connectors. The interface outputs <i>dCS</i> -encrypted DSD (1 bit data at 2.822MS/s), whether a CD or SACD is playing.
	2x AES/EBU on 3-pin male XLR connectors. Both output CD format data (16 bits at 44.1kS/s), whether a CD or SACD is playing.
	2x SPDIF on 1x RCA Phono. Both output CD format data, whether a CD or SACD is playing.
Clocking	Word Clock Output on 1x BNC connector. With the transport in Master mode, a TTL-compatible 44.1kHz word clock derived from the internal crystal oscillator is available on this output. The calibration accuracy when shipped is +/-10ppm, not temperature compensated. Calibration usually remains stable for several years, but this is not guaranteed.
	Word Clock Input on 1x BNC connector, accepts standard word clock at 44.1kHz. Sensitive to TTL levels, input impedance is 75Ω.
Size and weight	460mm (18.1") W x 400mm (15.8") D x 110mm (4.4") H including feet. Allow extra depth for cable connectors. Allow space for air flow around the unit.
	Weight 11.5kg (25.3lbs).
Power requirements	Internally set to either 100, 115/120, 220 or 230/240V AC, 49 – 62Hz.
	Power consumption: 20W typical, 30W maximum.

These specifications are subject to change without notice.

MAINTENANCE AND SUPPORT

Service and Maintenance

dCS audio products are designed not to need regular maintenance, and contain no user serviceable parts apart from the mains fuse. If your unit is damaged in any way, please contact your dealer.

Replacing a Blown Mains Fuse

There is a mains fuse below the power inlet, accessible from the outside of the unit. If the fuse blows, it may be changed by the user. The current consumption of the unit is very low, so it only blows if power surges occur, or there is a fault in the unit. Usually power surges cause no other damage, but if the fuse blows repeatedly on replacement, some other damage will have been done and the unit will need to be repaired.

Fuse type: 20mm x 5mm T0.5 amp L fuse



If the fuse should fail, it is essential that it is replaced with one of the same type and rating. Failure to do so could result in damage to the unit, risk of fire or electric shock and will invalidate the warranty.

Referring to the diagram below, remove the power cable, use a small flat bladed screwdriver to pry up the tab on the fuse carrier (A) and pull it out. Push the blown fuse out of the clip in the carrier (B) and dispose of it. Fit a new fuse in the clip (C) and push the carrier back into the unit so that it clicks home. Spare fuses are provided with the unit.

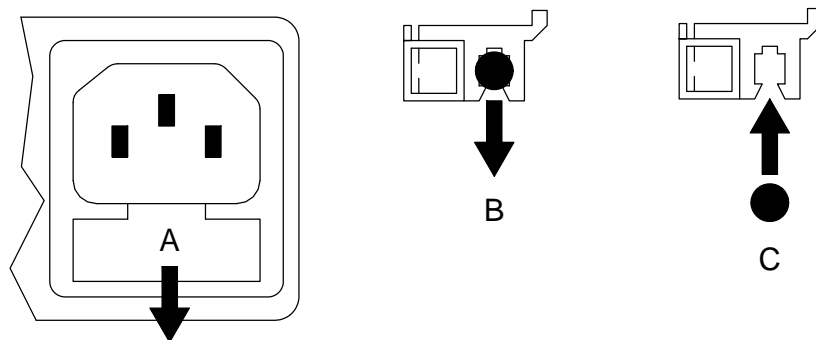

Cleaning the case

The front panel of your dCS equipment is machined from very high grade aluminium. Great care has been taken to create the finish of the aluminium throughout the engineering process from the raw solid material to the finished piece.

To remove loose dust or finger marks from the case, we recommend that you use a clean, dry, lint-free cloth.

To restore the finish on the front panel, we recommend applying small quantities of a lanolin based cleaner, using a clean, dry, lint-free cloth and then wiping off. Do not allow lanolin to collect around the buttons.

Small amounts of glass cleaner containing ammonia may be used to clean other surfaces, but avoid spraying onto the connector contacts.

Limited Warranty

General

dCS warrants this product against defects in materials and workmanship for a period of 3 years from the date the unit was originally shipped from dCS. During the warranty period, dCS will repair or, at our absolute discretion, replace a faulty product. Warranty repairs must only be carried out by dCS or our authorised service agents. Please contact your dealer if your unit requires service.

Your dealer should have completed on your behalf an **Owner Registration** form at the time of sale and returned it to dCS. On receipt of the Owner Registration form, dCS will add your contact details to our customer database. dCS will use this information for warranty purposes only, we will not contact you directly for reasons relating to sales and marketing.

This warranty applies to the original owner.

Warranty Exclusions

The Warranty does not cover wear and tear.

The Warranty on this product will be void if:

- the product is misused in any way.
- any unauthorised modifications or repairs are carried out.
- the product is not used in accordance with the Operating Conditions stated in this manual.
- the product is serviced or repaired other than by dCS or our authorised service agents.
- the product is operated without a mains earth (or ground) connection.
- the unit is returned inadequately packed.

dCS reserve the right to apply a service charge if a product returned for warranty repair is found to be operating correctly, or if a product is returned without a returns number being issued.

This warranty covers parts and labour only, it does not cover shipping charges or tax/duty.

Our dealers or distributors are NOT authorised to extend the terms of this warranty, dCS cannot accept responsibility for any attempt to do so.

Products re-sold by dCS on a "used" basis may be subject to reduced warranty terms.

Obtaining Service

Should you encounter a problem, contact your authorised dCS dealer for advice, quoting the model, the full serial number, software version number, and giving a detailed description of the fault. Your dealer will advise you fully on actions that need to be taken. When returning a unit, the original packaging should be used to avoid transit damage. Replacement packaging sets may be purchased from dCS.

During the Warranty period, there will normally be no charge for parts or labour.

Operating Conditions

- The supply voltage must remain within +/-10% of the A.C. voltage specified on the back panel.
- The supply frequency must be in the range 49Hz to 62Hz.
- Ambient temperature range: 0°C (32°F) to 40°C (104°F), non-condensing.
- Do not install the unit near heat sources such as radiators, air ducts, power amplifiers or direct strong sunlight.
- If in doubt, the easy test is – the unit is happy to work anywhere a human is.

If you need more help

In the first instance, you should contact your dealer. If they cannot resolve the issue, contact your national distributor.

Manufactured by:

Data Conversion Systems Ltd.
Unit 1, Buckingway Business Park,
Anderson Road,
Swavesey,
Cambridge. CB24 4AE
UK

www.dcsLtd.co.uk

This user manual may be downloaded free of charge from our web-site.

A bound copy of this manual may be ordered from *dCS*.

Software History

dCS products make extensive use of software configurable chips – FPGAs and DSPs. This gives us the ability to update our products to add extra features, update digital interface standards or make performance improvements by loading new software. Occasionally, a hardware upgrade may be necessary also to increase the “capacity” of the electronics, add extra connectors or extra front panel controls.

Please note that not all software updates make an earth-shattering change. You should have a clear idea of what you expect to gain before updating to the latest issue. We recommend that you keep your software up to date. Check the *dCS* web-site for the latest software updates.

This manual is for *Paganini Transport* software version 1.0x.

Issue 1.00 - The first issue, with 1394 issue 3.00.

Issue 1.02 – Bug fixes to improve reliability.